

Le figure seguenti mostrano come effettuare la sostituzione del regolatore RPC 5LGA con il regolatore RPC 7MGA.

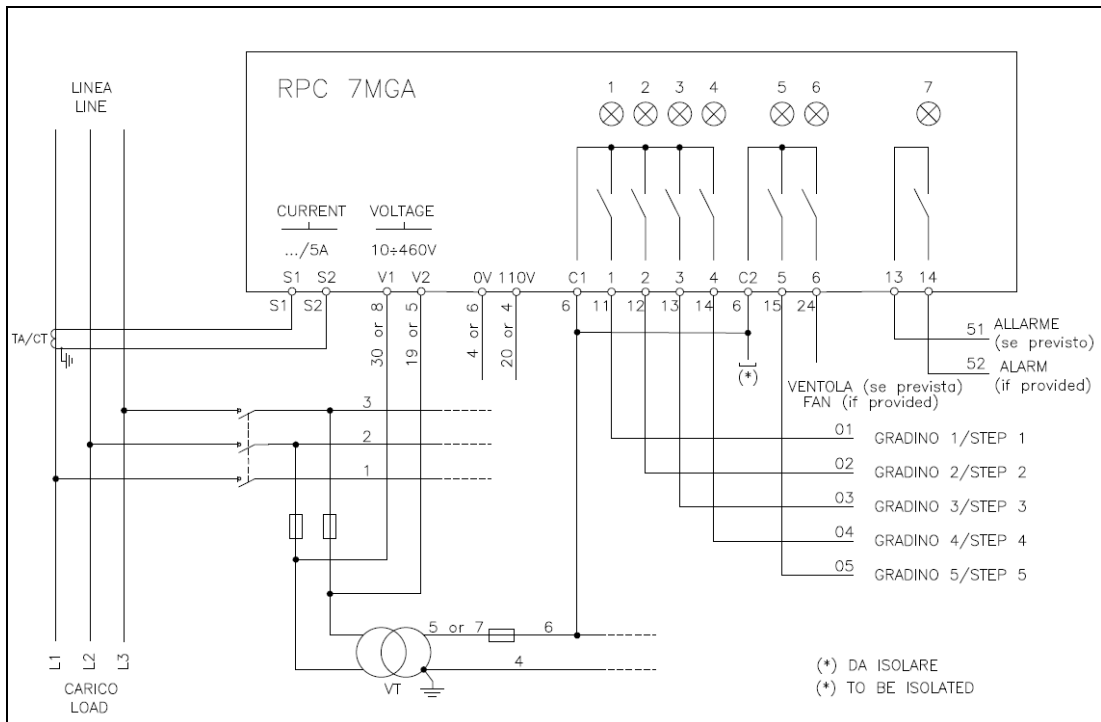

The following figures show how to replace the RPC 5LGA regulator with the RPC 7MGA regulator.

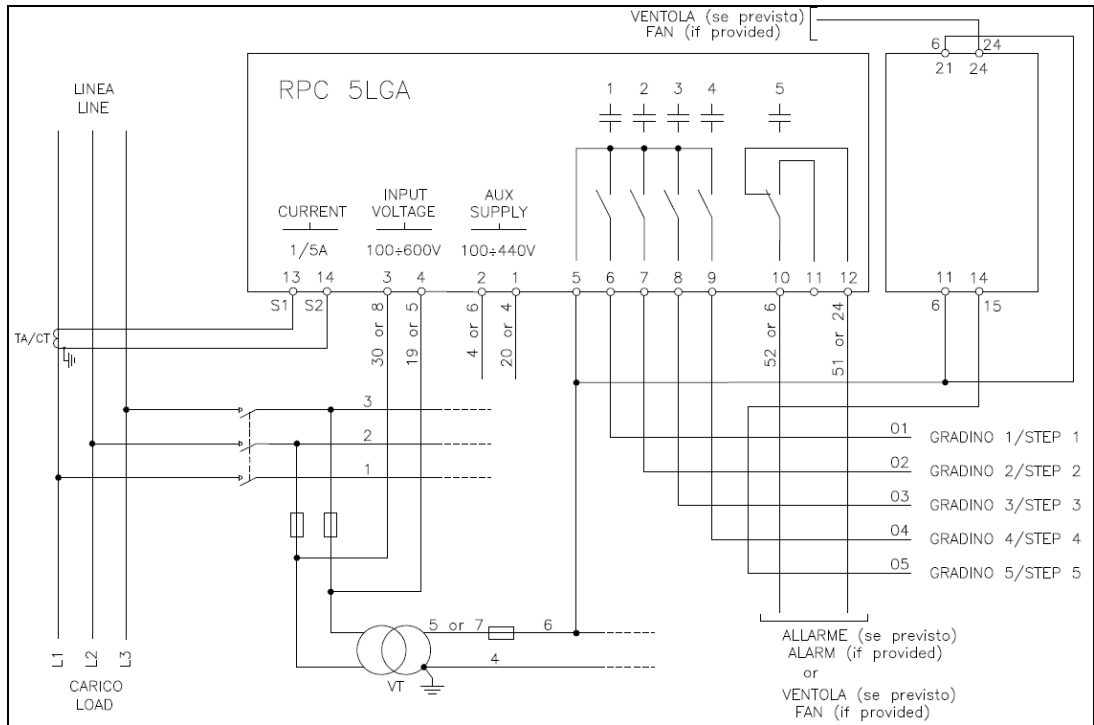